

# LINA Master Clock

## User Guide

## Your guide to LINA

This User Guide is designed to help you experience the full potential of your dCS LINA Master Clock.

Inside, you'll find advice on how to set up, install, use and care for your system. We ask that you read it carefully before getting started. If you require further information or support, you can contact us at [dcsaudio.com/contact](https://dcsaudio.com/contact).

We hope you enjoy listening, and are delighted to welcome you to the dCS community.

## Document information

Published on: 16/03/2022

Document ID: DCS322671 - Rev1.0

## Copyright

Copyright © 2022 Data Conversion Systems Ltd. All Rights Reserved.

Information contained in this manual is subject to change without notice, and whilst it is checked for accuracy, no liabilities can be accepted for errors.

dCS is Data Conversion Systems Ltd. Company registered in England No. 2072115.

dCS is a registered trademark of Data Conversion Systems Ltd.

Other product and company names may be trademarks or registered trademarks of other companies, and are the property of their owners. They are used only for explanation, without intent to infringe.

## Intended purpose

This document advises users how to set up, use and configure the product.

## Conventions in this document

This document uses the following safety notices and tips:



### **WARNING**

Indicates a hazardous situation which, if not avoided, could result in death or serious injury.



### **CAUTION**

Indicates a hazardous situation which, if not avoided, could result in moderate injury, damage the product, or lead to loss of data.

### **NOTICE**

Indicates an important situation which, if not avoided, may seriously impair operations.



Additional information relating to the current section.

# Contents

<b>Safety</b>	<b>5</b>
<b>Getting started</b>	<b>7</b>
Introducing the LINA Master Clock	7
What's in the box	7
Where to place the LINA Master Clock	7
Recommended cables and connectors	8
<b>Overview</b>	<b>9</b>
Front	9
Rear	9
<b>Setting up</b>	<b>11</b>
Connecting the power supply	11
Switching the unit on and off	11
Connecting the LINA range	12
Using Power Link	15
<b>Maintenance</b>	<b>16</b>
Replacing a blown mains fuse	16
Cleaning the unit	17
<b>Specifications</b>	<b>18</b>
<b>Support</b>	<b>19</b>
<b>Limited warranty</b>	<b>20</b>
General information	20
Warranty exclusions	20
Obtaining service	21
Operating conditions	21
<b>Compliance</b>	<b>22</b>
Product label	22
FCC compliance statement	23
EU Declaration of Conformity	23
Korea Class B compliance statement	24

# Safety

To prevent personal injury or damage to the unit, read the following safety messages before use.



## CAUTION

Read and comply with all safety messages and instructions in this document.

- Follow the cleaning instructions in this document.
- Only install the unit according to the instructions in this document.
- Do not spill liquid on the unit or allow it to get wet.
- Do not install the unit near heat sources.
- Use only the attachments and accessories specified by dCS.



## CAUTION

To prevent the risk of electric shock and ensure the best audio performance, connect the unit to mains earth (ground) using the correct power cable.

- A grounding type plug has two blades and a grounding prong, which is provided for safety. If the provided plug does not fit into your outlet, contact a qualified electrician.
- Do not use the power cable if it is damaged.
- If this unit is not being used for a long period of time, disconnect the unit from the power supply.
- During lightning storms, disconnect the unit from the power supply to prevent power surges.



## CAUTION

The safety covers on the unit protect you from electric shock.

- Do not remove the safety covers from the unit.
- If you do remove the safety covers from the unit, it invalidates the warranty.



## NOTICE

If the unit is damaged, do not use it and contact a qualified service engineer. Possible causes of damage to the unit include the following:

- Liquid is spilled on the unit.
- A heavy object falls on the unit.
- The unit is exposed to rain or moisture.
- The unit is dropped.

#### **NOTICE**

Damage caused to the unit by misuse of a mains regenerator or by a malfunctioning mains regenerator is not covered by the warranty.

- We do not recommend the use of mains regenerators.
- If you want to use a mains regenerator with variable voltage and frequency, set the voltage to match your local voltage. Set the frequency to either 50Hz or 60Hz.
- Do not change the output voltage of the mains generator while it is connected to the unit.

#### **NOTICE**

If the unit is cold and is moved into a warm room, condensation may form inside the unit. Condensation may interfere with the normal operation of the unit. If the unit has been kept somewhere cold, remove all packaging and leave it for 1-2 hours before using it to allow it to reach room temperature.

# Getting started

## Introducing the LINA Master Clock

The LINA Master Clock is an optional addition to your LINA system. While the LINA Network DAC and LINA Headphone Amplifier together deliver great performance, adding the LINA Master Clock improves the sound quality when using the network or USB inputs.

The LINA Master Clock generates word clock signals at 44.1 and 48 kHz, which have a very low jitter. After setting the LINA Network DAC to lock to a word clock, the LINA Network DAC automatically locks to the clock frequency that is an exact multiple of the incoming audio data. For example, if the incoming data rate is 192 kS/s, the LINA Network DAC selects the 48 kHz clock.

-  The LINA Master Clock cannot be used with source devices connected to the AES or SPDIF inputs on the LINA Network DAC, because there are no spare word clock outputs to connect an input to, such as a CD Transport. In these cases, select that input on the LINA Network DAC and use the Audio sync mode.

## What's in the box

The box contains the following items:

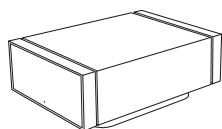

dCS LINA Master Clock

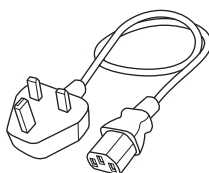

Power cable (2m)

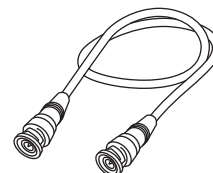

2x BNC cable (0.5m)

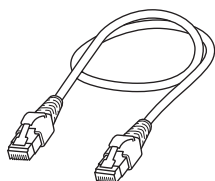

Power Link cable (0.5m)



Getting Started Guide

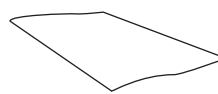

Welcome letter

If an item is missing from the box, contact your fulfilment centre.

-  We recommend that you keep the original packaging of the unit. If you need to order replacement packaging, contact your fulfilment centre.

## Where to place the LINA Master Clock

To get the best sound quality:

- You can stack units vertically or place them next to each other.
- Ensure you can easily connect LINA Master Clock to other units of your system.

- If units are stacked vertically, place the bottom unit on a firm, vibration-free base.
-  To prevent overheating, we recommend that you leave some space around the units to allow for ventilation.

## Recommended cables and connectors

We recommend the following cables and connectors for use with the unit. We supply "commercial" cables with the unit, but you can use cables and connectors of your preferred quality.

### NOTICE

Heavy or inflexible power cables may damage the power socket on the unit.

-  Some "audiophile" cables have unusual grounding or screening arrangements, or they don't have the correct characteristic impedance. If you have difficulty using such cables but the problem disappears when you use standard cables, contact your cable manufacturer.

Output	Recommended cable and connector
Word Clock	75 $\Omega$ coax cables fitted with BNC connectors.

-  The Word Clock sockets require a simple DC-coupled connection. If you use capacitor-coupled cables or cables with built-in networks, the interfaces may not work correctly.



# Overview

## Front

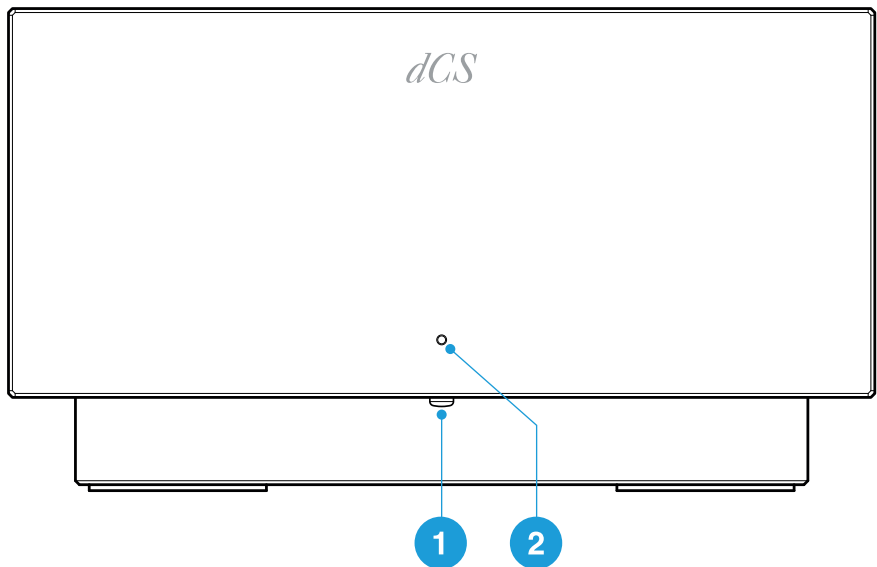

Item	Description
1 Power button	To switch on or enter sleep mode, press briefly. To switch off, press and hold until the status indicator turns off.
2 Status indicator	When in sleep mode, the status indicator is dim white. When the unit is on, the status indicator is bright white.

## Rear

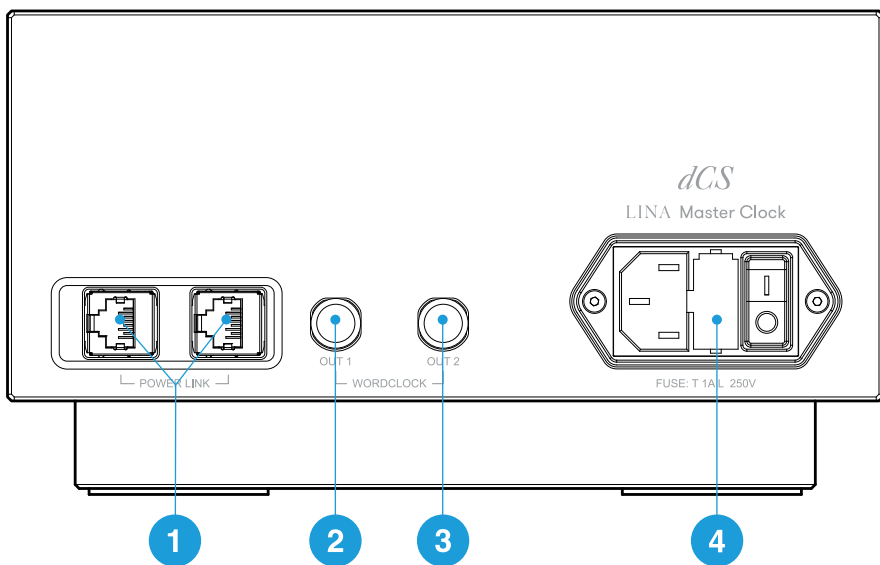

	Item	Description
1	<i>POWER LINK</i>	RJ45 input. Connects the unit to other LINA units to enable Power Link. ▶ <i>For more information, see "Using Power Link" on page 15.</i>
2	<i>WORDCLOCK OUT 1</i>	Word clock output 1. A 75Ω BNC connector, fixed at 44.1kHz. Connects the unit to an audio device such as a DAC. Word clock is only used for synchronisation and does not carry digital audio data.
3	<i>WORDCLOCK OUT 2</i>	Word clock output 2. A 75Ω BNC connector, fixed at 48kHz. Connects the unit to an audio device such as a DAC. Word clock is only used for synchronisation and does not carry digital audio data.
4	Power socket, fuse, and power switch	Power is connected via a standard IEC320 connector, with a power switch and a fuse holder.

# Setting up

## Connecting the power supply

Use the supplied power cable to connect your LINA Master Clock to the power supply.

1. At the rear of the unit, insert the power cable into the power socket.
2. Connect the plug to a power supply.

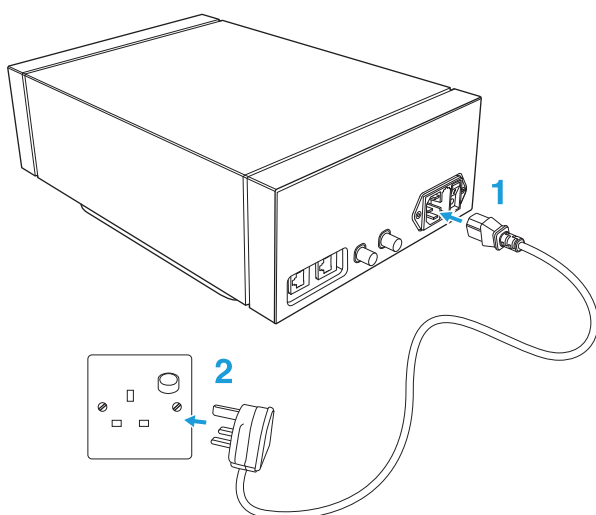

## Switching the unit on and off

At the rear of the unit, there is a power rocker switch next to the power cable. There is also a power button on the front panel.

To switch on the unit:

1. On the rear of the unit, press the power rocker switch to the / position.

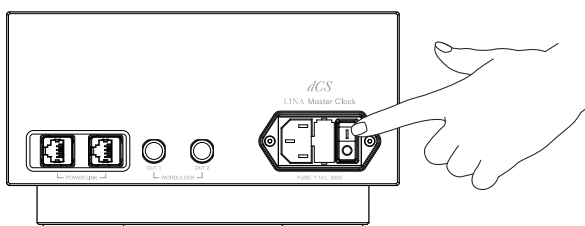

2. On the front of the unit, press the *Power* button.

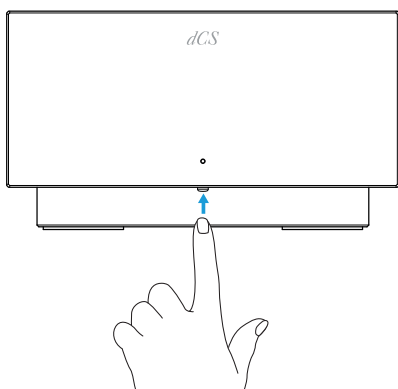

To switch off the unit:

- Press and hold the *Power* button until the status indicator turns off.

## Using sleep mode

Sleep mode suspends the unit in its current state, but keeps it ready for quick use.

- To enter sleep mode, briefly press the *Power* button.
- To exit sleep mode, press the *Power* button again.

## Connecting the LINA range

To connect the LINA Network DAC, LINA Master Clock and LINA Headphone Amplifier together:

1. Position the LINA range.
2. Connect the LINA Network DAC to the LINA Headphone Amplifier.
3. Connect the LINA Master Clock to the LINA Network DAC.

### I. Positioning the LINA range

You can position the units in one of the following ways:

- Place the units side by side.
- Stack the units vertically in the following order:
  - LINA Headphone Amplifier at the bottom
  - LINA Master Clock in the middle
  - LINA Network DAC on top



To prevent overheating, we recommend that you leave some space around the units to allow for ventilation.

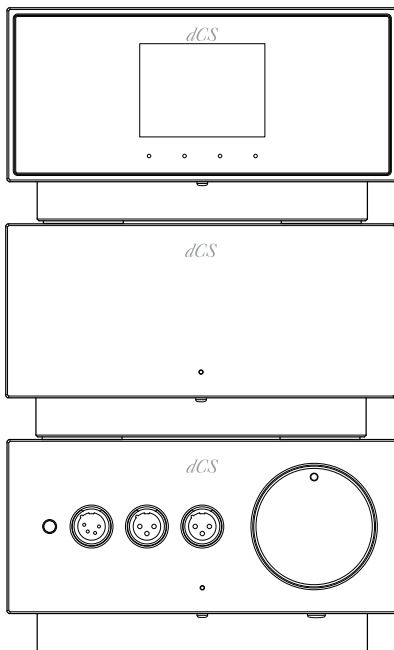

## 2. Connecting the LINA Network DAC to the LINA Headphone Amplifier

You can connect the LINA Network DAC to the LINA Headphone Amplifier using the balanced XLR sockets.

- Using two balanced XLR cables, connect the *BAL. LEFT* and *BAL. RIGHT* outputs on the LINA Network DAC to the *BAL. LEFT* and *BAL. RIGHT* inputs on the LINA Headphone Amplifier.

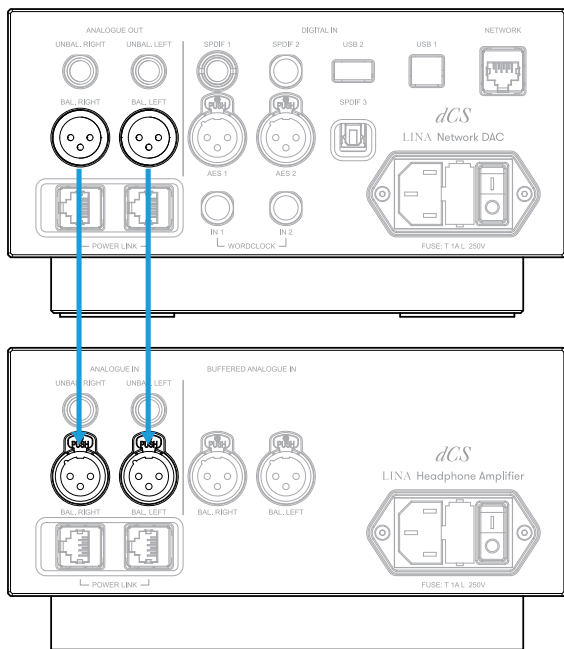

- On the LINA Headphone Amplifier, choose the unbuffered XLR input. If the status indicator is not white, press the *Power / Input* button until it changes to white.

## 3. Connecting the LINA Master Clock to the LINA Network DAC

You can lock the network and USB inputs on the LINA Network DAC to the LINA Master Clock.

- Switch on the LINA Network DAC and the LINA Master Clock.
- On the LINA Network DAC, choose the network or USB input.
- Using two BNC cables, connect the *WORDCLOCK* output sockets on the LINA Master Clock to the *WORDCLOCK* input sockets on the LINA Network DAC.

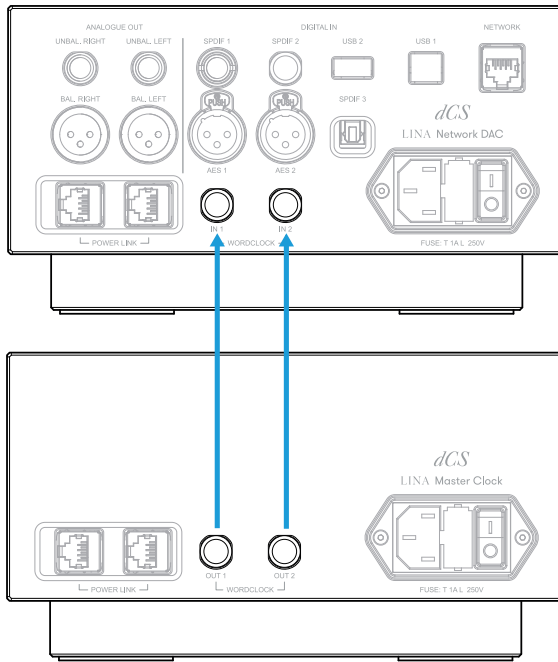

4. Set the clocking sync mode on the LINA Network DAC to Auto  $\overset{w}{\rightleftarrows}$ .  
 The LINA Network DAC selects the appropriate clock input and locks to it.

 If you lock an AES or SPDIF input on the LINA Network DAC to the LINA Master Clock, the source equipment will not be locked to the Clock, resulting in periodic clicks, dropouts or distortion.

To use the LINA Network DAC in this way, use source equipment that has a word clock input and a Master Clock with extra outputs.

# Using Power Link

Power Link allows you to switch LINA units on and off at the same time, or put the LINA Network DAC and LINA Master Clock in and out of sleep mode at the same time.

To enable Power Link, use two RJ45 cables to connect the *POWER LINK* sockets on each unit.

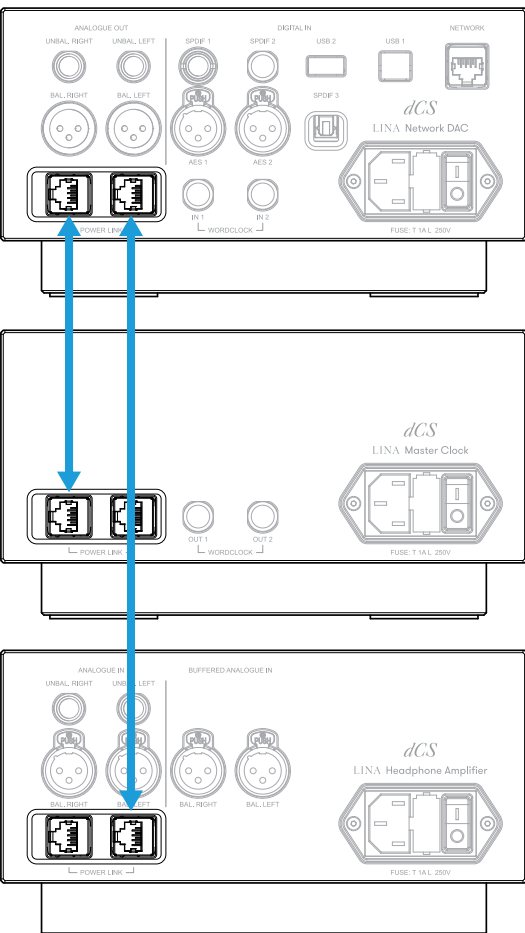

# Maintenance

dCS audio products do not need regular maintenance. The only user-serviceable part of the unit is the mains fuse. If the unit is damaged, contact your fulfilment centre.

## Replacing a blown mains fuse

There is a fuse within the unit's power inlet. If the fuse blows, you can replace it.

- If the fuse blows once, replace the fuse. There was a power surge.
- If the fuse blows repeatedly, contact your fulfilment centre to arrange repair. There is a fault in the unit.

Fuse type: 20 x 5 mm, T 1A L / 250 V



### WARNING

Replace the fuse with one of the same type and rating. If you use a fuse of a different type or rating, it may damage the unit and there is a risk of fire or electric shock. It also invalidates the warranty.

To replace a blown mains fuse:

1. Unplug the power cable from the unit.
2. Next to the power rocker switch, push the two tabs of the fuse holder towards the centre and pull out the fuse holder.

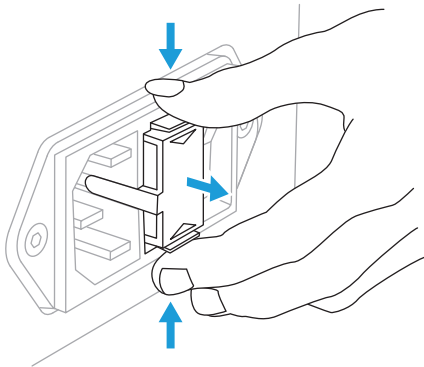

3. Remove the blown fuse from the lower position of the fuse holder.

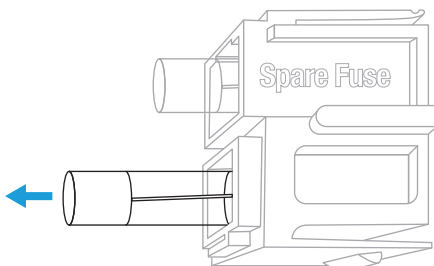

4. Replace the blown fuse with the spare fuse from the upper position.



5. Push the fuse holder back into the unit with the writing the correct way up, until you hear a click.

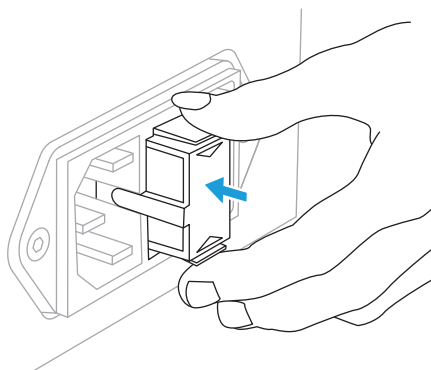

## Cleaning the unit

If the case of the unit gets dusty or dirty, you can clean it with a lint-free cloth.

- To remove fingerprints and loose dust, use a clean and dry lint-free cloth.
- To clean any other surfaces, use a small amount of glass cleaner containing ammonia and a lint-free cloth. Do not spray glass cleaner directly onto the connector contacts.

# Specifications

<b>Clock type</b>	Grade 1 Master Clock. Features dual crystal oscillators within a locked OCXO/VCXO design.
<b>Clock frequencies</b>	44.1 kHz and 48 kHz
<b>Clock accuracy</b>	Better than +/-1 ppm when shipped over an ambient temperature range of +5° C to +45° C.
<b>Word clock outputs</b>	2x independently buffered, TTL-compatible output on 75 Ω BNC connectors: <ul style="list-style-type: none"> <li>• Output 1: fixed at 44.1 kHz</li> <li>• Output 2: fixed at 48 kHz</li> </ul>
<b>Power Link</b>	2x RJ45
<b>Start-up time</b>	Typically 10 minutes to rated accuracy.
<b>User interface</b>	<ul style="list-style-type: none"> <li>• Power button</li> <li>• Status indicator</li> <li>• Power switch</li> <li>• Power synced via Power Link</li> </ul>
<b>Shipping dimensions</b>	250 mm (H) x 300 mm (W) x 450 mm (D)
<b>Shipping weight</b>	10 kg
<b>Product dimensions</b>	121.5 mm (H) x 220 mm (W) x 339 mm (D)
<b>Product weight</b>	7 kg
<b>Power requirements</b>	90-120 V / 220-240 V, 50/60 Hz Power consumption: 10 W



These specifications are subject to change without notice.

# Support

If you need help using your LINA Master Clock, contact your fulfilment centre for assistance, quoting the serial number of your unit.

Manufactured by:

Data Conversion Systems Ltd.  
Unit 1, Buckingway Business Park,  
Anderson Road,  
Swavesey,  
Cambridgeshire,  
CB24 4AE,  
UK

[www.dcsaudio.com](http://www.dcsaudio.com)

# Limited warranty

## General information

dCS warrants this product against defects in materials and workmanship for a period of 3 years from the date the unit was originally shipped from dCS. If the product is purchased and registered with dCS within 6 months of the date the unit was originally shipped from dCS, we will start the warranty on the purchase date. For units registered later than 6 months from the ship date, we will start the warranty from the ship date unless the registration is supported by the original sales invoice. During the first year of the warranty period, dCS will repair or, at our absolute discretion, replace a faulty product. For the remaining two years, service will be covered, but any parts needed will be chargeable. Warranty repairs must only be carried out by dCS or our authorised service agents. Please contact your fulfilment centre if your unit requires service.

To register this product, either register online at [www.dcsaudio.com/register](http://www.dcsaudio.com/register) or complete the Product Registration form within 30 days of the sale and return it to dCS. On receipt of the registration, dCS will add your contact details to our customer database. dCS will use this information for warranty purposes only, we will not contact you directly for reasons relating to sales and marketing.

This warranty applies to the original owner, it is not transferable.

## Warranty exclusions

The warranty does not cover wear and tear.

The warranty on this product will be void if:

- the product is misused in any way.
- any unauthorised modifications or repairs are carried out.
- the product is not used in accordance with the Operating Conditions stated in this manual.
- the product is serviced or repaired other than by dCS or our authorised service agents.
- the product is operated without a mains earth (or ground) connection.
- the unit is returned inadequately packed.

dCS reserve the right to apply a service charge if a product returned for warranty repair is found to be operating correctly, or if a product is returned without a returns number being issued.

This warranty covers parts and labour only, it does not cover shipping charges or tax/duty.

Our fulfilment centres and service agents are not authorised to extend the terms of this warranty, dCS cannot accept responsibility for any attempt to do so.

Products re-sold by dCS on a “used” basis may be subject to reduced warranty terms.

## Obtaining service

Should you encounter a problem, contact your fulfilment centre or authorised service centre for help, quoting the model, the serial number, the software version (where appropriate) and giving a detailed description of the fault. Your contact will advise you fully on actions that need to be taken. When returning a unit, the original packaging should be used to avoid transit damage. Replacement packaging sets may be purchased from dCS.











## Operating conditions

- The supply voltage must remain within +/-10% of the A.C. voltage specified on the back panel.
- The supply frequency must be in the range 49 Hz to 62 Hz.
- Ambient temperature range: 0°C (32°F) to 45°C (113°F), non-condensing.
- Do not install the unit near heat sources such as radiators, air ducts, power amplifiers or direct strong sunlight.

# Compliance

## Product label

The product label on the bottom of the unit provides information about the unit, including the serial number. It also displays safety, compliance and regulatory markings.

Marking	Description
	Intended to alert the user to the presence of uninsulated dangerous voltages within the product's enclosure, which may be sufficient in magnitude to constitute a risk of electrical shock to the user.
	Caution: To prevent electrical shock, do not remove covers. No user serviceable parts inside. Refer any servicing to a qualified technician.
	This product is not suitable for operation at altitudes above 2000m.
	The user instructions contain important cautionary information (warnings/precautions) and must be read before using the product. Keep the user instructions in a safe place.
	This product conforms with the requirements set out in the European CE directives when installed and used in accordance with this manual. For continued compliance, servicing must be referred to a qualified service technician.
	The product is compliant with UK standards.
	The crossed out wheellie bin (WEEE symbol) is the European symbol for indicating that this equipment must not be disposed of in general rubbish. You are liable to dispose of all your electronic or electrical waste by relocating to the specified collection point for recycling of hazardous waste. Collection, proper recovery and recycling of electronic waste equipment at the end of the product life cycle will allow us to help preserve the environment. Please return the unit or contact your fulfilment centre for more information.
	The product is compliant with EU2015/863 on restricted substances.
	This equipment has been tested and found to comply with the limits for a Class B digital device, pursuant to Part 15 of the FCC Rules. ► For more information, see "FCC compliance statement" on the facing page.
	This product is in compliance with the China Compulsory safety scheme as administered by CNCA and meets safety and EMC requirements.
	This product is in compliance with Korean product safety and has been awarded the Korean certificate (KC) mark.

## FCC compliance statement



This equipment has been tested and found to comply with the limits for a Class B digital device, pursuant to part 15 of the FCC Rules.

These limits are designed to provide reasonable protection against harmful interference in a residential installation. This equipment generates, uses and can radiate radio frequency energy and, if not installed and used in accordance with the instructions, may cause harmful interference to radio communications. However, there is no guarantee that interference will not occur in a particular installation.

You can determine whether this equipment is causing interference by turning it off. If the interference stops, it was probably caused by the equipment or a peripheral device.

If your equipment does cause interference to radio or television reception, try to correct the interference by one or more of the following measures:

- Turn the television or radio antenna until the interference stops.
- Move the equipment to one side or the other of the television or radio.
- Move the equipment further way from the television or radio.
- Plug the equipment into an outlet that is on a different circuit from the television or radio. (That is, make certain the equipment and the television or radio are on circuits controlled by different circuit breakers or fuses.)

(USA only) If necessary, consult dCS Americas LLC or an experienced radio / television technician for additional suggestions.

Changes or modifications not expressly approved by dCS Americas LLC could void the manufacturer's warranty.

This product has demonstrated electromagnetic interference compliance under conditions that included the use of compliant peripheral devices and shielded cables between system components. In order to maintain compliance with FCC regulations, shielded cables (including Ethernet network cables) must be used with this equipment. Operation with non-approved equipment or unshielded cables is likely to result in interference to radio and TV reception.

Responsible party (contact for FCC matters only)

dCS Americas LLC,  
PNC Bank Bldg,  
300 Delaware Ave, Suite 210,  
Wilmington, DE 19801,  
USA

## EU Declaration of Conformity

This equipment has been tested and found to comply with the essential requirements of the following Directives: 2014/30/EU, 2014/35/EU and 2015/863/EU.

This device is certified for indoor use only.

## Korea Class B compliance statement

This equipment is for home use, and has acquired electromagnetic conformity registration, so it can be used not only in residential areas, but also other areas.

이 기기는 가정용(B급) 전자파적합기기로서 주로 가정에서 사용하는 것을 목적으로 하며, 모든 지역에서 사용할 수 있습니다.